

# ARTIFICIAL INTELLIGENCE PLANNING TECHNIQUES FOR ADAPTIVE VIRTUAL COURSE CONSTRUCTION

## TÉCNICAS DE PLANIFICACIÓN EN INTELIGENCIA ARTIFICIAL PARA LA CONSTRUCCIÓN DE CURSOS VIRTUALES ADAPTATIVOS

NÉSTOR DARÍO DUQUE

*Ph.D. Profesor asociado Universidad Nacional de Colombia – Sede Manizales. G ndduqueme@unal.edu.co*

DEMETRIO ARTURO OVALLE

*Ph.D. Profesor titular Universidad Nacional de Colombia – Sede Medellín. dovalle@unal.edu.co*

Received for review August 5<sup>th</sup>, 2011, accepted March 14<sup>th</sup>, 2011, final version April, 14<sup>th</sup>, 2011

**ABSTRACT:** This paper aims at presenting a planning model for adapting the behavior of virtual courses based on artificial intelligence techniques, in particular using not only a multi-agent system approach, but also artificial intelligence planning methods. The design and implementation of the system by means of a pedagogical multi-agent approach and the definition of a framework to specify the adaptation strategy allow us to incorporate several pedagogical and technological approaches that are in accordance with the teamwork points of view, thus providing a very concrete implementation and installation. A novel pre-planner was included that allows transparency and neutrality within the proposed model and which also offers support to translate the virtual course elements within a planning problem specification. The final section exhibits the experimental platform SICAD+ (*Sistema Inteligente de Cursos ADaptativos+*, meaning “Intelligent System for Adaptive Courses through a Multi-Agent System approach”), which validates the model proposed.

**KEYWORDS:** AI planning techniques, multi-agent systems, adaptive virtual course construction

**RESUMEN:** El artículo tiene como objetivo proponer un modelo de planificación para la adaptación de cursos virtuales, basado en técnicas de inteligencia artificial, en particular usando el enfoque de sistema multi-agente (SMA) y métodos de planificación en inteligencia artificial. El diseño y la implementación por medio de un SMA pedagógico y la definición de un framework para especificar la estrategia de adaptación permiten incorporar diversos enfoques pedagógicos y tecnológicos, de acuerdo a los puntos de vista del equipo de trabajo, lo cual resulta en una implementación e instalación concreta. Se incorpora un novedoso pre-planificador que permite la transparencia y la neutralidad en el modelo propuesto y también ofrece soporte para traducir los elementos del curso a las especificaciones de un problema de planificación. La última sección muestra la plataforma experimental SICAD + (Sistema Inteligente de Cursos ADaptativos, a través de un enfoque multi-agente), que valida el modelo propuesto.

**PALABRAS CLAVE:** técnicas de planificación en IA, sistemas multi-agente, construcción de cursos virtuales adaptativos

### 1. INTRODUCTION

In the 70s it was expected that information and communication technologies (ICT) would improve education, making significant contributions to learning, in particular for personalized education. In such a design, each student would be recognized individually, the specific student's rhythm of learning would be respected, and different paths towards the proposed educational objective would be followed, using the enriched learning objects and multi-modal activities provided [1,2,3]. However, Dastbaz et al. (2006) establish that these promises, even now, are not being met, and many of the e-learning models are

quite a lot more than the old text-based computer-aided learning running on a global network.

Current research is focused on the technological challenges of creating and using these environments as well as on their potential to support competition, collaboration, communication, and improved socialization skills. The community advances in different topics, looking forward to making their promises and hopes come true; plus, the evaluation of the diverse tendencies in virtual education systems position both adaptive systems and intelligent pedagogical systems as front line topics in researches and proposals [5,6].

This paper proposes a model for customized virtual courses supported in a generic adaptation strategy using multi-agent systems (MAS) and other artificial intelligence (AI) techniques. The course generation module is of particular interest, consisting of a pre-planner and a planner, which take advantage of the AI planning techniques to deliver a personalized plan.

The rest of the paper is organized as follows: Section 2 outlines main concepts of adaptive educational systems; afterwards, Section 3 introduces the proposal, and Section 4 presents the components and whole process of the system. An overview of the experimental platform that supports the model is presented and described in Section 5. Finally, conclusions and future work are presented in Section 6.

## 2. ADAPTIVE LEARNING

The adaptability of a system may be defined as its capacity to dynamically adapt its behavior to the requirements of the user-system interaction [7]. Recently, the term personal learning environment has begun to be used to describe and classify technology-supported learning systems.

There are several components susceptible to adaptability in a virtual education system: interfaces, the course plan, pedagogical strategies, retrieval information, and the evaluative process, which involves the integration of individual with collaborative learning activities.

A real and thorough customization process requires a determined adaptation strategy, which implies defining which aspects to adapt, the conditions for such an adaptation, the objectives pursued and the way in which it will all be done. In other words, What should we adapt? When should we adapt? What are the adaptability goals and the adaptability rules [8]? Particularly in the case of educational systems such a strategy must also take into account the request of the International Community expressed in the 3rd workshop of authoring of adaptive and adaptable educational hypermedia carried out in Holland in the year 2005 [9]. This request focuses on determining what the main characteristics are to model in the student, defining how to formulate the pedagogical knowledge in a reusable way while supporting pedagogical scenarios and regarding the cognitive styles.

The adaptation technologies in Web systems may be summarized in the adaptive selection of contents, adaptive navigation support, and adaptive presentation. Duque et al. [10] establish that such an adaptation can also be seen at several moments of the educational process and that these techniques can be oriented to curriculum sequence, to adaptive support for collaborative tasks, to knowledge level assessment, to intelligent analysis of solutions, and to intelligent information recovery.

## 3. ADAPTIVE GENERIC MODEL FOR VIRTUAL COURSES

An adaptive educational model definition requires the precise determination of a variety of components in such a way that they may be handled in the adaptation process. On one hand, the adaptation task must define the relevant elements of the student profile that determine the customization (student model); and on the other hand, the course must be represented in such way that it can be adapted according to the needs of the learners (a domain model), specifying the components which can be adapted, according to the focus of the system. The automation of this process requires and demands a clear adaptation strategy that conjugates these elements through rules or algorithms, which balancing the expected needs and goals, will deliver a customized course to each student. This is represented in Fig. 1.

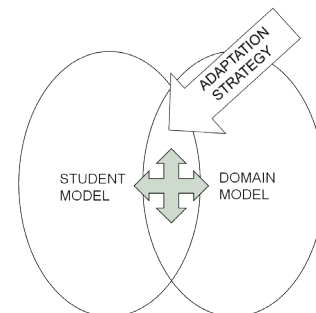

**Figure 1.** Adaptive model components in educational systems

The solution to this problem requires the combination of two efforts: the first one encompasses pedagogical and educational technologies; the second one includes information technologies used for designing and building computational learning systems. AI techniques have shown their advantages, including applying case-based reasoning (CBR), neuronal networks (NN), AI planning, Bayesian networks (BN), fuzzy

systems, genetic algorithms (GA), especially the multi-agent system (MAS) which seems to be a promising alternative [11,12,13,14,15,16].

The model we propose is shown in Fig. 2. It presents the clear separation between the structure of the course (represented through the hierarchical educational objectives (EOs) to be achieved) and the teaching materials or educational units (EUs) that support the educational activities according to various pedagogical strategies, applied to the differences among learners. The most relevant characteristics inside the educational process are defined for the student in the psychological, psycho-pedagogical (learning styles), non-permanent characteristics, and technological contextual levels. His or her academic profile is stored in terms of the EOs obtained.

The planning and re-planning strategy becomes complex since when the course is being structured, the fine granularity of the EUs and the heterogenic characteristics of the students, through applying a variety of intelligent techniques helps overcome a large part of the difficulties without giving up on the adaptive learning goal. This process is guided through metadata, that in the case of the EUs are extensions of the learning technology standard IEEE-LOM [17].

According to the challenges established by the community, this work defines a generic adaptation

strategy that allows the inclusion of diverse pedagogical and technological approaches. Thus, this strategy is performed based on the student profile, the specification and the organization of the pedagogical resources, and elements to adapt in the personalization of the course. This situation certainly creates new challenges and makes the task more complex.

The path to follow may be oriented by disintegration into functional blocks, without losing the systemic point of view, which leads to distributing the solution in diverse entities that require specific knowledge, processing and communicating among each other. Having these characteristics, modeling the problem using MAS seems to be a promising option. The main motivation for selecting MAS is the possibility of distributing the components of intelligence outlined by the solution on the proposed problem.

This situation has direct repercussions on the modular development of the system, which also makes it easier to refine or exchange each one of the aspects without substantially affecting the others, according to the approach chosen by the developer. Supporting such expectations, the theoretical reference proves that very good results have been achieved in solving similar problems to the one in discussion, based on pedagogical knowledge distribution and processing.

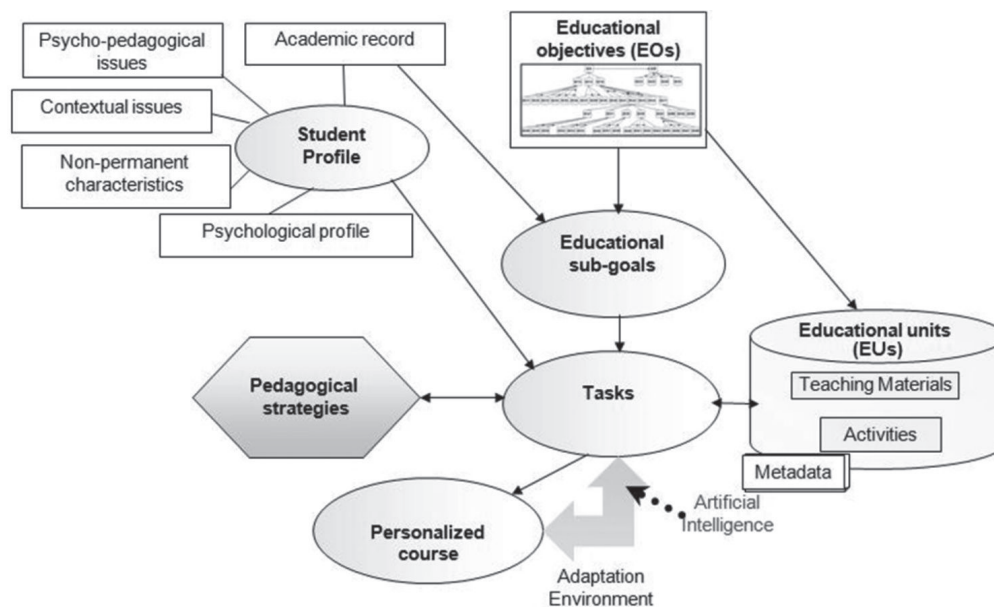

Figure 2. Generation of an adaptive virtual course [10]

The use case diagram shown in Fig. 3, displays the relationship among different actors and the functions within the system. Taking into account the perspective of multi-agent architecture, Section 4 presents all the components included in our proposed computational learning model.

#### 4. COMPONENTS AND DEVELOPMENT THE MAS

This section illustrates some aspects of the modeling phase of the MAS following the MAS-CommonKADS methodology [18], emphasizing the different components of the system. The MAS-CommonKADS methodology extends the knowledge engineering methodology CommonKADS with techniques from object-oriented and protocol engineering methodologies, defines the necessary models for the analysis and design phases, and provides complete documentation; besides this, other applications in similar cases report to have very positive results [19]. Nevertheless, the experienced acquired suggests including some models from other methodologies such as MaSE (Multi-agent system Software Engineering) [20] which uses hierarchical objective diagrams as support in dividing some complex tasks, and GAIA [21] which focuses on role modeling;

this issue being important in clearly determining what can be expected from the agent.

Some examples of the conceived models are showed in Fig. 4. The reasoning mechanism must be specified for the description of the tasks which require knowledge, and this mechanism determines how the elemental inferences are integrated in order to achieve an EO. The description of the conversations among agents is made both in graphical and textual representations. In addition, the Organization Model, which describes the structural relationships between software agents, is also presented. A complete diagram depicting the proposed system is presented in Fig. 6.

The student agent allows handling diverse elements in the profile of the learner according to particular interests. Forms and tests supplied by the supporters of the included characteristics are used for input information, such as psychological tests, learning styles tests, socio-grams, and some others directly obtained from the system during the interaction process. For the update, two pathways are established: Firstly, new tests or forms providing new student’s learning enhancement information; secondly, monitoring the actions of the student, and in some cases through machine learning by using data mining techniques on logs and collected data.

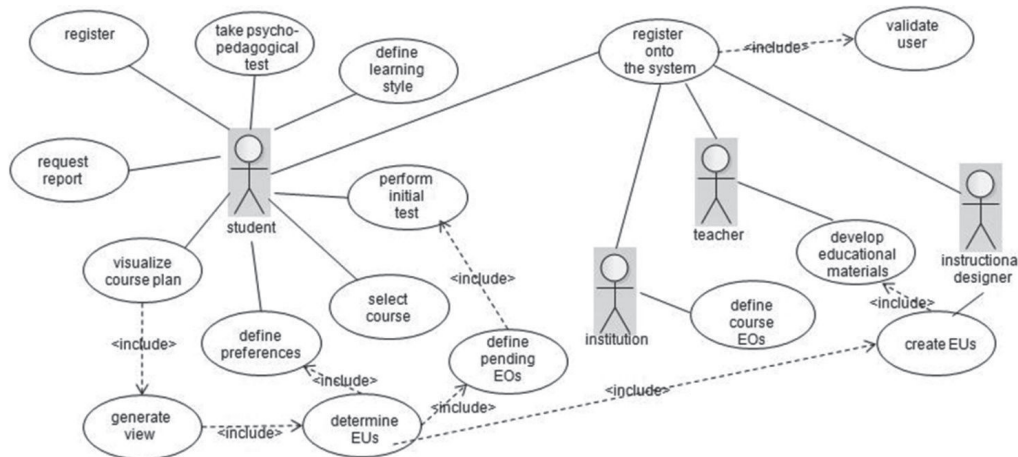

Figure 3. Use case diagram

The domain agent manages the structure of the course associated to an acyclic graph whose nodes are the EOs to be achieved, while keeping the information of the EUs or pedagogical resources (PRs). Concerning the student’s learning assessment process, performing tests,

input tests, and so on, are performed by the diagnostic agent who, in order to apply the tests, gives a previous classification to the student in one of the knowledge categories established.

The local retrieval agent is in charge of the retrieval of the stored learning objects and has only information about the way in which the resources will be received, permitting the agent to use diverse visions for the resource composition, naming and allocation, and supporting standard technologies particularly related with learning objects, such as LOM and DCMI.

As can be seen, the adaptation strategy is embedded within the planning agent which is internally an artificial planning system of a hierarchical task network (HTN) that allows the personalized course to be created [22]. Previous works have taken advantage of artificial intelligence planning techniques, in particular, the HTN planner for composition courses [23,24,25].

In this case, taking the process of generating a customized course to a planning problem implies

defining the triplet (S, T, D): where S represents the initial state of the student (academically, pedagogically, etc.) described in the language of the planner; T symbolizes the list of tasks to be achieved in order to obtain the expected results; and D represents the domain of the planner conformed by operators (Os) that define the direct actions that can be executed. They are of the form (h(v) Pre Del Add) and the methods (M) that represent the macro-operators that permit the aggregation of a list of actions and are of the form (h(v) Pre T), or more general form as (h(v) Pre1 T1 Pre2 T2 . . . Pren Tn). In addition, we include a novel pre-planner oriented to the automated generation of the planner domain which is used by the course generation plan. On the other hand, the pre-planner allows transparency and neutrality for the proposed model. Figure 5 shows the equivalences between course elements and the pre-planner and planner problem arguments.

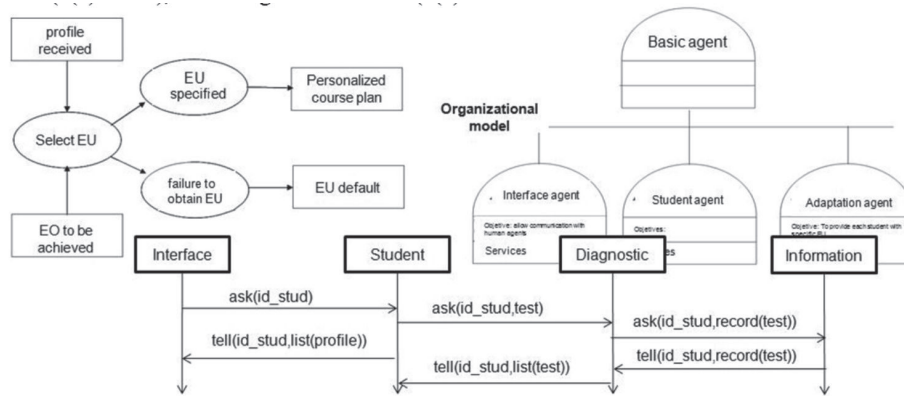

Figure 4. Artifacts of the models used in the development of the MAS

Translating the course generation problem into planning environment implies the definition of operators, methods, and problem planning in SHOP2 terms [26]. The algorithms required for translating the domain course for planning environment specifications are presented next.

**EU\_O: EU into an operator:**

$$O = (EU.id (EU.prereq) (\phi) (h(EU.id)) (EU.cost))$$

Where:

EU.id: EU identifier,

EU.prereq: prerequisite,

EU.cost: Size or cost of the Educational Unit (this variable could be replaced by instruction typical time or similar), and,

h(EU.id): Procedure that returns the EO that the given EU supports.

**EO\_M: Compose EO into a method:**

$$M=(EO.id (f(EO.id)) (g(EO.id)))$$

Where:

EO.id: EO identifier,

f(EO.id): Procedure that returns EO\_PRE.prereq,

g(EO.id): Procedure that returns Sub\_EOn, EO.id, and,

(Sub\_EO1, Sub\_EO2, ... , Sub\_EOn): Educational Objectives children or sub-objectives.

And

**EU\_M : Several EUs for single EO into a method**

$M=(EO.id ((EU1.Ch EU1.id)(EU2. Ch EU2.id)... (EU_n. Ch EU_n.id))$

Where:

EO.id: EO identifier, and,

Ch n: Characteristic associated to EUn, in particular, Learning Style.

**EUc\_M: Compose EU into a method:**

$M=(EU.id (h(EU.id)) (j(EU.id)))$

Where:

EU.id: EU identifier.

h(EU.id): Procedure that returns EU\_PRE.prereq,

j(EU.id): Procedure that returns Sub\_EUn, EU.id, and,

(Sub\_EU1, Sub\_EU2, ... , Sub\_EUn): Educational Units children or sub-units.

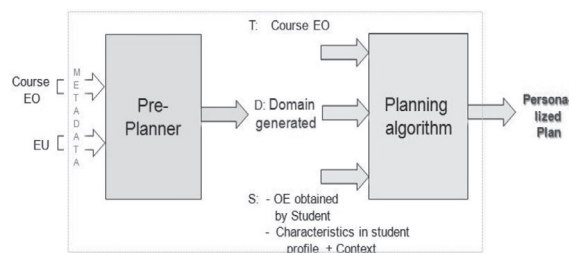

Figure 5. Pre-planning and planning for course generation

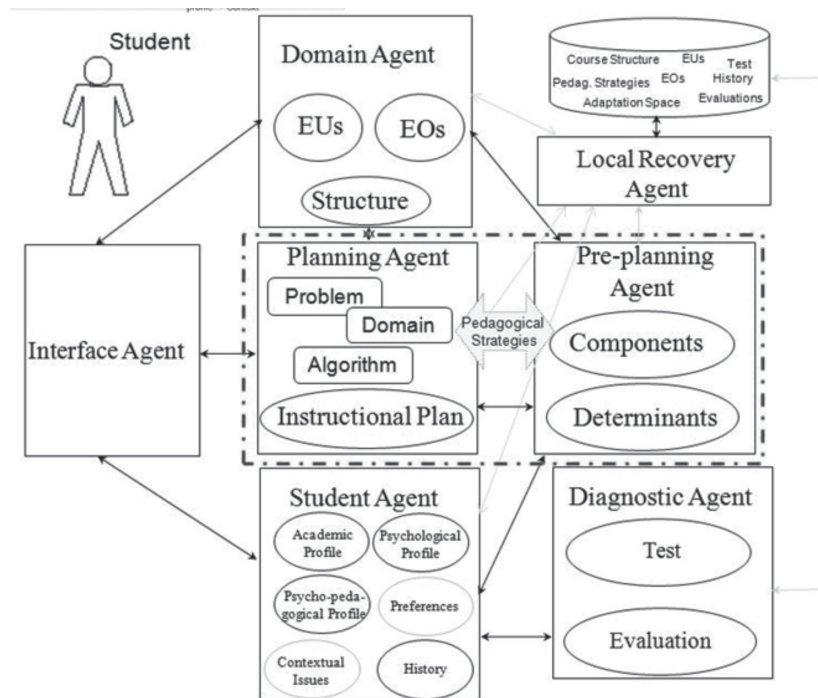

Figure 6. General architecture of the adaptive pedagogical MAS proposed

### Course Domain into a SHOP2 Domain

From the course generation problem to a SHOP2 planning problem:

- Inputs: Initial conditions of the student (achieved goals and Learning Style), Educational Objectives proposed to the course.
- Output: Planning problem SHOP2 in the form (S, T, D)

Procedure:

1.  $S = ((EOL1, EOL2, \dots, EOLn) Ch)$

$EOLn \subseteq EO$ , where  $EOLn$  are the EOs achieved by the student and  $Ch$  is his/her characteristic (Learning Style, psychological, etc.).

2.  $T$ : Set of tasks to achieve, expressed in terms of EOs: ( $EO1, EO2, \dots, EOn$ ).

3.  $D$ : Domain, conformed by methods and operators, obtained in the previous steps.

The instructional plan, obtained from SHOP2 planner is a sequence of EUs, taking (S, T, D) as inputs at a given specific moment. The planning algorithm allows for the process to advance from the initial state and starts covering the required tasks according to T, by the application of the methods and operators in D that support the declared strategy. At the end, the customized plan is deployed as a sequence of activities supported by the EUs (operators) that must be developed by the student in order to achieve the proposed objectives involved in the course.

If the execution of the plan does not produce the expected results, or the student finds it difficult to achieve the EOs, it is necessary to re-plan the course locally or globally. As a sound and simple alternative, the technique known as case-based reasoning (CBR) may be selected by the program developer. The main issue involving CBR is that it offers similar solutions to similar problems, which allows the system to reuse successful solutions for similar problems. Particularly, in this case, it implies retrieving the information

obtained by the system from related successful experiences, assisting the objectives proposed for students with similar profiles.

### 5. SICAD-MAS, EXPERIMENTAL PLATFORM

The intelligent systems of adaptative courses—multi-agent system (SICAD+) is an experimental platform supported by the proposed computational model. The system was designed for virtual courses in a Web platform, under a client/server scheme.

It is development-free software based on multiplatform tools (Windows, Linux) that allow its access from any Web navigator. Figure 6 shows the system's software elements and the relationships through which they interact. The SICAD+ is based on the previously established topics; it is completely functional and can be used for the assembly of diverse virtual courses and for applying different pedagogical trends.

The web server is Apache Software Foundation Tomcat 6.20, with support for the database engine MySQL 5.0. The programs were developed in Java j2sdk1.6.0. The SmartUpload (which permits the system to upload files to Servlets and JSP) and MySQL\_Driver libraries were particularly used as well. The multi-agent platform was build on Java using the JADE framework [27], advantages that simplify the MAS construction and provides a set of tools for system debugging.

Figure 7 presents the architecture of the SICAD+ platform, component and the intelligent agents. The integration between the presentation layer (JSP) and the multi-agent platform is performed through the JadeGateway library offered by JADE.

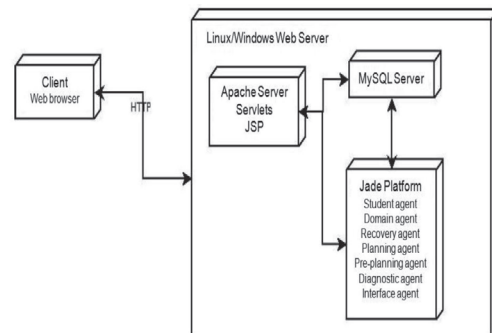

Figure 7. SICAD+ architecture

The system permits the professor to administrate elements of the virtual course (users, educational objectives, or educational units) in order to construct courses based on EOs that comprise it, to automatically generate the domain of the planner, and to execute it for the personalized generation of each course, as is shown in Fig. 8, for a particular case study.

## 6. CONCLUSIONS AND FUTURE WORK

The computational approach presented in this paper allows for one to see how AI techniques are becoming important tools in the complex personalization of the educational process. Modeling the problem using a MAS technique was an excellent option, allowing disintegration into functional blocks, without losing the systemic perspective. In addition, this approach leads the developer to distribute the solution in diverse entities that require an exchange of specific knowledge, processing, and communication. The MAS allows for the neutral vision in the proposed model.

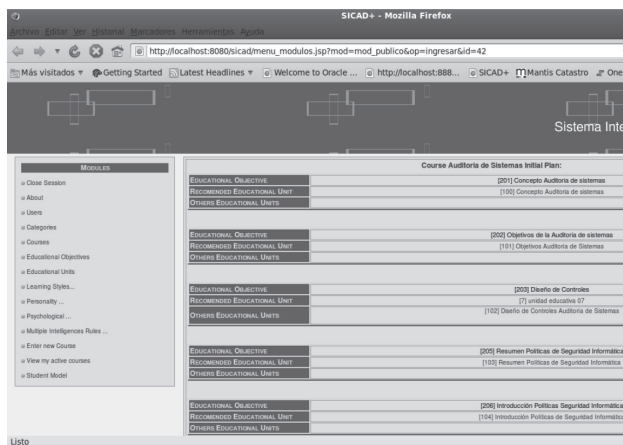

Figure 8. SICAD+ personalized course

In the personalized courses, the difficulty is in changing the construction outlines. It is very important to define the structure of the course, and to compose it with highly granular elements, which will help to achieve very detailed adaptations. Thus, the elements that must be taken into account in each student should be specified along with specific related educational materials, learning objects, and activities.

The SICAD+ platform is already under the process of improvement, particularly, refining the execution process, the implementation of others modules, and

evaluation with a control group for determining how to improve teaching-learning strategies.

## REFERENCES

- [1] Eraut, S., Un método de sistemas instructivos en el desarrollo del curso. *Psicología de la educación*, recopilación E. Stones, Tomo II, Ediciones Morata, Madrid. 1970.
- [2] Stolurow, L. S. C.A.I. Algunos problemas y perspectivas. *Psicología de la educación*, a cargo de E. Stones, Tomo II. Ediciones Morata. Madrid. 1970.
- [3] Alfaro, L., Pereira, F., Jacintho, L., Modelagem de um Ambiente Inteligente para a Educação baseado em Realidade Virtual. *Memorias IV Congresso RIBIE*. Brasilia. 1998.
- [4] Dastbaz, M., Mustafa, A, Stoneham, R., Issues in Design and Development of Personalised E-Learning Systems. *Memorias. ED-MEDIA 2006. World Conference on Educational Multimedia, Hypermedia & Telecommunications*. Orlando. USA. 2006.
- [5] ITS 2006. Proceedings of 8th International Conference on Intelligent Tutoring Systems. Taiwan. 2006.
- [6] ED-MEDIA 2006. Memorias World Conference on Educational Multimedia, Hypermedia & Telecommunications. Orlando. USA. 2006.
- [7] Duque, N. Modelo adaptativo multi-agente para la Planificación y ejecución de cursos Virtuales personalizados. Tesis de Doctorado en Ingeniería. Universidad Nacional de Colombia – Sede Medellín. 2009.
- [8] Karagiannidis, C., Koumpis, A., Stephanidis, C., Deciding 'What', 'When', 'Why', and 'How' to Adapt in Intelligent Multimedia Presentation Systems. *Proceedings of the 12th European Conference on Artificial Intelligence*, Budapest, Hungary. 1996.
- [9] Cristea, A., Carro, R., Garzotto, F., Presentation of A3EH: The 3rd workshop of Authoring of Adaptive and Adaptable Educational Hypermedia. *AIED*. Holland. 2005.
- [10] Duque, N., Ovalle, D., Jiménez, J., Artificial intelligence for automatic generation of Customized courses. *Proceedings of the ED-MEDIA 2006-World Conference on Educational Multimedia, Hypermedia & Telecommunications*, USA. 2006.
- [11] Jiménez, J., Un Modelo de Planificación Instruccional usando Razonamiento Basado en Casos en Sistemas Multi-



Agente para entornos integrados de Sistemas Tutoriales Inteligentes y Ambientes Colaborativos de Aprendizaje Apoyados en Computador. Tesis Doctoral en Ingeniería. Universidad Nacional de Colombia - Sede Medellín. 2006.

[12] Vicari, R., Agentes Inteligentes en Educación Virtual. Memorias. Seminario Internacional. Inteligencia Artificial y Seguridad. Pereira, Colombia. 2005.

[13] Merida, D., Fabregat, R., SHAAD: Sistema Hipermedia Adaptable, Adaptativo y Dinámico para entrega de Contenidos Hipermedia. Universidad de Girona. 2003.

[14] Martins, W., Diniz de Carvalho, An intelligent tutoring system based on self-organizing maps- design, implementation and evaluation. Memorias ITS 2004. Brasil.

[15] Nakagawa, M., Kuroda, T., A Case-Based Reasoning System on the Internet for References of Information Technology Education to Teachers. Proceedings of the International Workshop on Current Trends and Applications of Artificial Intelligence in Education, Ayala, G. 2004.

[16] Silveira, R., Modelagem Orientada a Agentes Aplicada a Ambientes Inteligentes Distribuidos de Ensino: JADE Java Agent framework for Distance learning Environments. Universidade Federal do Rio Grande do Sul. Tesis Doctoral. 2001.

[17] IEEE. Learning Technology Standards Committee. Learning Object Metadata Standard Maintenance/Revision. 2002.

[18] Iglesias, C., Definición de una metodología para el desarrollo de sistemas multiagente. Tesis doctoral. Departamento de ingeniería de sistemas telemáticos. Universidad Politécnica de Madrid. 1998.

[19] Jiménez B., J. Ovalle C, D., Branch B. J. Conceptualización y análisis de un sistema multi-agente pedagógico utilizando la metodología MAS-CommonKADS. Revista Dyna 158, 2009.

[20] Deloach, S., Multiagent Systems Engineering Of Organization-Based Multiagent Systems. Proceedings of the 4th International Workshop On Software Engineering For Large-Scale Multi-Agents Systems Selmas'05, St. Louis. 2005.

[21] Wooldridge M., N. J., Kinny D., The Gaia Methodology For Agent-Oriented Analysis And Design. International Journal Of Autonomous Agents And Multi-Agent Systems. 2000.

[22] Nau, D., Tsz-Chiu, A., Kuter, U., Murdock, W., WU, D., Yaman, F., SHOP2: An HTN Planning System, Journal of Artificial Intelligence Research. Disponible [www.cs.cmu.edu/afs/cs/project/jair/pub/volume20/nau03a.pdf](http://www.cs.cmu.edu/afs/cs/project/jair/pub/volume20/nau03a.pdf). 2003.

[23] Duque M, N D., Jiménez, C., Guzmán, J., IA Planning for Automatic Generation of Customized Virtual Courses. Frontiers in Artificial Intelligence and Applications. Amsterdam. Holland. 2005.

[24] Morales, LL., Castillo L., and Fernández-Olivares J., Planning for Conditional Learning Routes. MICAI '09 Proceedings of the 8th Mexican International Conference on Artificial Intelligence. Springer-Verlag Berlin, Heidelberg, ISBN: 978-3-642-05257-6. 2009.

[25] Ullrich a, C. and Melis B., E. Pedagogically founded courseware generation based on HTN-planning. Journal of Expert Systems with Applications, Vol 36, pp. 9319–9332. 2009.

[26] Duque M, N., Ovalle, D, and Silveira, R., Adaptive virtual courses development based on multi-agent system approach. WCCE 2009. Bento Gonçalves, Brasil. 2009.

[27] Bellifemine, G., Caire, C., Poggi, A., Rimassa, G., JADE: Java Agent Development Framework. A White Paper University of Parma. <http://jade.tilab.com/2006>.